

online catalog:  
[wardburner.com](http://wardburner.com)

number 38

burners

kiln accessories

ceramic fiber products

brick

safety equipment

combustion data guide

# Table of Contents

Aluminized Clothing.....	27
Aprons.....	27
Ball Valves.....	9
Baso Valves.....	13
Blowers.....	14
Board, Ceramic Fiber.....	6
Brick.....	5
Burner Stands.....	18
Ceramic Burner Heads.....	20
Ceramic Fiber.....	3
Ceramic Fiber Modules.....	4
Ceramic Fiber Hardware.....	4
Clamps, Burner.....	10
Clothes, Safety.....	27
Combustion Data.....	31
Controllers.....	11
Electrodes.....	7
Face Shields.....	28
Flash Hood.....	28
Fittings.....	10
Flame Relay.....	8
Flexible Gas Connectors.....	9
Gas Cocks.....	9
Gauges.....	15
Glossary.....	33
Gloves.....	26
Greenpatch 421.....	6
Hose, Propane.....	9
Insblock.....	6
Insboard.....	6
Intermittent Pilot Control.....	8
Kiln Shutoff Control.....	11
Mortars .....	6
Needle Valves.....	9,10
Nozzles.....	14

Ordering Information.....	30,31,32
Order Form. ....	34
Orifice Chart.....	16
Orifice Plugs & Spuds.....	16
Piggyback Venturi Burner.....	18,20
Pilot Burners.....	7,18,20
Pipe Sizing Chart.....	15
POL.....	10
Power Burners.....	17,18
Power Burner Examples.....	19
Pressure Gauges.....	15
Propane Tanks.....	24
Propane Tank Connectors.....	24
Pyrometers.....	11,12
Pyrometer Connectors.....	12
Pyrometer Wire.....	12
Quick Connects.....	10
Raku Burners.....	20,23
Raku Clothing.....	27
Raku Gloves.....	26
Raku Kiln Kits.....	25
Raku Tongs.....	24
Rectified Burners.....	22
Regulators.....	8,9
Sairset.....	6
Scanner, Ultra Violet.....	8
Safety Equipment.....	27
Shutoff / Soak Control.....	11
Solenoid Valves.....	13,18
Spark Ignition.....	7,18
Speed Controllers.....	7
Target Pilots.....	7
Thermocouple, Safety.....	13
Thermocouple, Temp.....	10
Venturi Burners.....	20,21
Wire, High Temp.....	4

Ceramic fiber is a great material for new kilns and furnaces or lining existing ones. In addition to the tremendous fuel savings offered by fiber, these products are easy to use, light weight, and durable. The fiber products listed are of two types: **2300°F** and **2600°F**. Temperature ratings on fiber and all refractory products, relate to their intermittent service limit and not their continuous duty rating. All ceramic fiber and refractories should be used at 250°F or more below their service limit. If your equipment runs in the 2300°F range, **2600°** fiber should be used at least on the inside 2" of hot face.

**NOTE:** Although ceramic fiber does not contain asbestos, fiber particles can be very irritating. The use of an approved respirator and protective clothing is necessary during construction & removal.

**Uses:**

- **Building all Types of Kilns & Furnaces**
- **Glass Annealing ovens & Glory Holes**
- **Lining for Electric Kilns**
- **Lining for Flues**
- **Lining for Brick Kilns**
- **Kiln Door Construction**

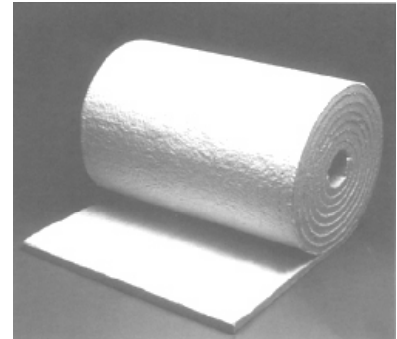

Unifrax has recently developed a revolutionary new silica-magnesia fiber that is soluble in lung tissue. Because of its unique chemistry it falls below regulatory thresholds and contains NO additional labeling or health warnings. **Isofrax™** also passes the more stringent EU protocols (European) regarding ceramic fiber products and has been exempted from classification or labeling as a potential carcinogen. Further, it is NOT listed as a hazardous material by the states of CA, NJ, or PA. It still may cause mechanical irritation, so proper clothing and respirators are still recommended. This is the only 2300°F ceramic fiber we now carry and use it exclusively in the production of our Raku kilns. We also sell a 2600°F 8lb density fiber made by Unifrax for higher temperature applications but, it does carry the health warnings that Isofrax is exempt from.

**Fiber Shrinkage Chart**

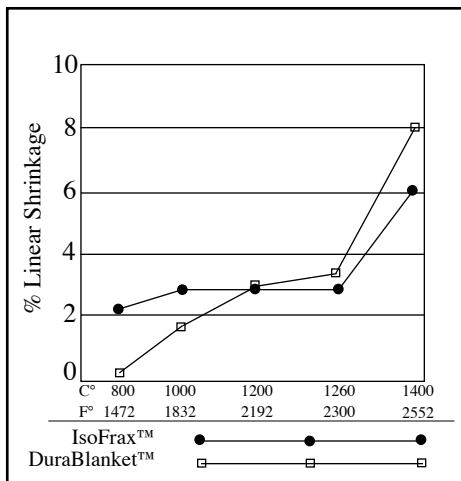

**All Rolls Measure; 2ft wide x 25ft long x 1" thick**  
(call for different thicknesses & widths)

**Isofrax.** A 2300°F low iron, high purity needled blanket for use in oxidation or reduction. 6lb density. We also sell this fiber by the running ft. (running ft = 2' x 1').

**full roll 6# - \$ 199.00      Running ft - \$ 12.50**

**Durablanket 2600** A 2600°F blanket featuring thermal stability, resistance to vibration, and thermal abuse. Available in 8 lb density

**full rolls only      8# - \$ 285.00**

**NOTE:** All ceramic fiber when repeatedly exposed to temperatures above 1800°F, begins to produce Cristobalite, a known carcinogen. Use proper precautions when removing used fiber from service.

# Ceramic Fiber Hardware

Ceramic Whistle Stud Assembly

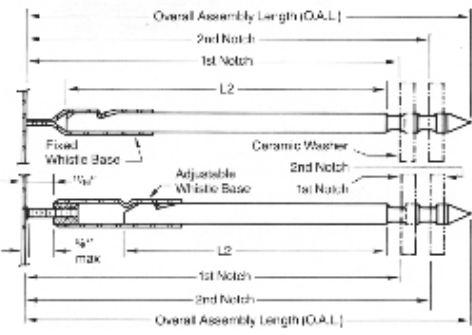

6".....	\$27.59	9".....	\$28.39
7".....	\$27.98	10"....	\$28.59
8".....	\$28.19	11"....	\$28.79

The Whistle Stud assembly is made from two different materials. The base, which is welded to the kiln shell, is made from stainless steel. The stud, which impales layers of ceramic fiber, is made from High Alumina. Reduction atmospheres are very destructive to metal anchoring systems. With this system, all exposed anchoring is High Alumina and impervious to the kiln atmosphere. Stud Assemblies come in a fixed base (top illustration) and adjustable (lower illustration) Prices are for the fixed base. Add \$1.25 per stud assembly for adjustable base. Select a stud 1" longer than your intended fiber thickness.

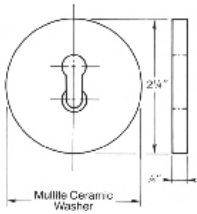

\$8.95

The above Whistle Stud assembly requires the use of a washer to hold the fiber in place. The Mullite Ceramic Washer on the left is designed to slide over the stud and lock into place. For areas, such as roofs, that require more support, the Ceramic Bearing Ring on the right is used in conjunction with the Ceramic Washer. Both are rated to 2450°F

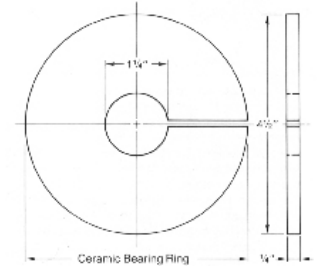

\$7.29

# Ceramic Fiber Modules



We carry 2600°F Ceramic Fiber Modules in two mounting types. The Screw-Loc® Module on the left uses a screw gun and supplied self-tapping screws to randomly mount to a solid metal shell. The Module can also be supplied with a bolt and large washer (on right) for random mounting to expanded metal mesh shells. After mounting, the compression bands are cut, the module expands and you have a tight, well sealed fiber wall that can easily be repaired if the need ever arises. Modules uncompress to 12 x 12 inches and come in 3 different thicknesses.

6"	\$76.95
8"	\$86.95
10"	\$99.95

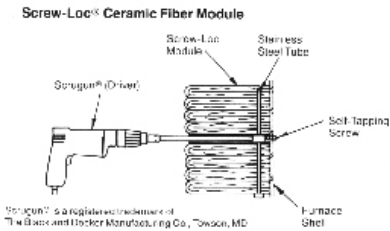

# High Temperature Wire

**High Temp. Wire.** A 15ga wire used for making staples or element pins. When used with homemade clay washers or pieces of ceramic fiber, it holds fiber to the kiln shell. A good system for Raku kilns.

Less than 50' - \$ .70 per ft	over 50' - \$ .55 per ft
-------------------------------	--------------------------

To Order Call: (865) 397-2914 4

New Castle Refractories

a division of



**Insulating & Hard Brick**

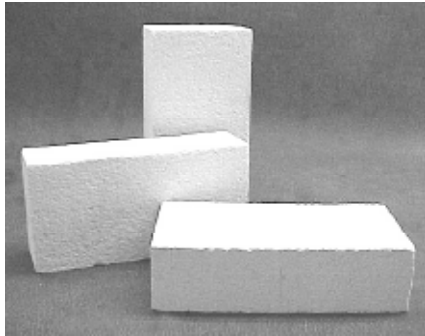

standard size for straights:  
9" x 4.5" x 2.5"

New Castle Insulating Brick is some of the finest brick made. We carry 2300°F & 2600°F Insulating brick in straights, #1 arch, #2 arch, and wedges. Prices are per brick. Bricks are packed 25 to a carton for straight Insulating brick. Arches and wedges are sometimes 30 to a carton and sold in carton quantities only. Hard brick is shipped loose on pallets. Bricks are standard 2 1/2" series. Call for different shapes and sizes.

Qty.	1-24	25-100	125-1400	>1400
LW-23 straights	4.20	3.85	3.15	call
LW-26 straights	4.85	4.25	3.65	call

for arches & wedges add .45 per brick to the prices above.

Prices on brick reflect the drop-shipped price from the brick plant. To hold down brick prices, we feel it is better to ship bricks just once. For smaller quantities, we ship brick from our facility. When bricks are shipped from our facility via UPS, there will be a \$10.00 handling fee per carton in addition to shipping charges. Prices listed above, reflect brick price only and do not include shipping. Bricks may be combined to total quantity pricing.

**Mt. Savage Firebrick**  
High Duty Hard Brick

Mt. Savage High Duty hard brick is a dense, tough, dry-pressed brick that will hold up to all your kiln needs. It is rated to Cone 32 with a cold crushing strength of 3000-4000 psi. Brick weight is 131-135 lbs. per cubic foot, or roughly 8 lbs per brick. Brick is shipped stacked on pallets from the factory, 456 bricks per pallet. Prices are for standard 9" x 4.5" x 2.5" brick. There is a \$30.00 charge anytime pallet size is broken. 125 brick minimum.

**Chemical Analysis**

Silica	58.90%
Alumina	34.55%
Ferric Oxide	1.92%
Titania	2.31%
Calcium Oxide	0.16%
Magnesia	0.18%
Alkalines	1.98%

125-455 pcs..... \$2.85  
456-912 pcs..... \$2.70  
>912..... Call

NOTE: We also carry High Alumina Brick in different Alumina percentiles. Please call for specific Alumina percentiles and pricing.

**Ceramic Fiber Board**

- Backup Insulation for Fiber
- Back up for Bricks or Castables
- Combustion Chamber Linings
- Gaskets & Seals
- Kiln & Stack Linings
- Jewlery Soldering Boards



Ceramic fiber or mineral wool formed into rigid boards has many uses. They are noted for their low thermal conductivity and excellent handling strength. It is easily machined, drilled, sawed, and fabricated. Available in temperature ratings of 1900°F, 2300°F, 2600°F.



**Insblok 19** is a lightweight mineral wool block that retains its stability and high thermal efficiency. It is honeycombed with countless dead air cells for maximum insulating value, yet its interlocking fibrous structure produces a tough resilient block. **Not recommended for hot face applications, backup only.**

**1" x 1' x 3'....16pcs per carton....ctn: \$199.00**  
**less than carton: \$ 7.50 sq/ft**

**Inboard 23** is a lightweight refractory board processed from alumina-silica fibers formed into a board. Its intermittent service limit is 2300°F. Board measures 1" x 24" x 36".

**\$ 139.00 per board**  
**less than full board: \$ 49.00 per sq/ft**

**Inboard 26** is the same as above but with a higher intermittent service limit of 2600°F

**\$ 169.00 per board**  
**less than full board: \$ 57.50 per sq/ft**

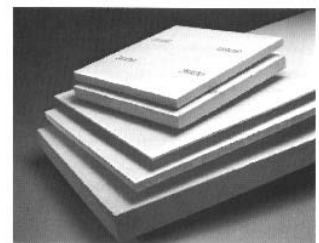

**Mortars**



**Sairset** is a wet, high temperature, air setting mortar that is an excellent troweling mix to bond fiber, brick, and metal. Made with colodial silica to provide stickiness. Apply in thicknesses under 1/8".

**15 lb pail.....\$ 36.50**

**55 lb pail.....\$ 86.50**

**Greenpatch 421** is very similar to SAIRSET but can be used in any thickness to bond, fill, or coat. Comes wet and ready to trowel.

**15 lb pail.....\$ 36.50**

**55 lb pail.....\$ 86.50**



**Honeywell**

This pilot burner can be used on burner systems where wind and port blowback is not a factor and that use an intermittent pilot control (see page 8). This burner is made from steel. Some pilots of this style are made, in part, of aluminum which can melt from the high ambient port temperatures of stoneware kilns. **NOTE: May be unstable at pressures greater than 2 PSI.**

Price: \$58.95

**Speed Controller**

This solid state speed control is designed for use with PSC (permanent split capacitor) or shaded pole blowers like the ones we use on our MB POWER BURNERS. Ordinary dimmer switches can damage the motors mentioned above.

Price: \$ 37.50

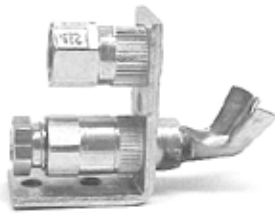
**Target Type Pilot Burner****Honeywell**

This pilot burner can be used on all types of burner systems where wind and port blowback is not a factor. It energizes the thermocouple and ignites the main flame front. A threaded coupler holds the thermocouple in perfect position. This burner is made from steel. Some pilots of this style are made, in part, of aluminum which can melt from the high ambient port temperatures of stoneware kilns. **NOTE: May be unstable at pressures greater than 2 PSI.**

Price: \$56.95

**Spark Ignitor**

The CAM-STAT P120 is used to protect a standing pilot from being extinguished. The unit works by emitting very intense, pulsed electrical arcs. The electrode senses a flame outage in less than 1 second and begins pulsing at 300 cycles per minute until the flame is re-established. It's automatic and instant lighting makes this unit a very safe and trouble-free addition. Must be wired to a **properly** grounded 120Vac line.



Price: \$ 89.50

**Heavy Duty Electrode & Wire**

For those requiring a heavier and longer (6") electrode, this unit can be used with the Cam-stat P120 above. A more durable electrode than supplied with the Cam-Stat. Heavy silicon, high-temp wire with spark plug cage is the wiring method.

Electrode: \$19.95    Wire w/cage: \$8.50 per foot

## Intermittent Pilot Control

8

To Order Call: (865) 397-2914

This safety control is designed for indirect burner ignition and supervision. Used with a rectifying pilot, it provides spark ignition and flame monitoring with shutdown times under 1 second. Can be used with all fuel gases. This is a 24volt system designed to be used with 24volt solenoids.



BASO Gas Products LLC

Price: \$159.00

## Ultraviolet Scanner



The C7027A Minipeeper is a compact flame detector for use with the Honeywell R7023C Flame Relay. The scanner detects ultraviolet radiation emitted by main flame or pilot flame. Mounting: 1/2" NPT nut for mounting to 1/2" sight pipe. Comes with 6 ft. Leads

Price: \$189.00

## Flame Detector Relay

This Honeywell Flame Detector Relay Series 7800 comes in many different models that will provide proven flame in many applications. Unit prices include sub-base and appropriate amplifiers. Used with an electric solenoid valve, it can provide 100% shut off in less than 1 second. This is an industry standard and is the safest means of flame monitoring and shutdown. 120 or 240 volts AC. Please specify.



Price: \$1299.00

## Low Pressure - 2 Stage Regulator



Similar in nature to a gas grill regulator, this regulator reduces tank pressure to low pressure (11" water column) but, provides over 6 times the volume of a gas grill regulator.

Price: \$39.50

## High Capacity LP Regulators

These regulators, made by REGO, are first and second stage regulators. The first stage reduces tank pressure to a set outlet pressure of 10psi. The second stage reduces pressure from 10psi or less to 11" water column pressure. Both will handle capacities of 800,000 BTUs @ 1" pressure drop.

First Stage Price: \$82.50 Second Stage Price: \$ 72.95



## High Capacity Adjustable Regulators



The model 597 high pressure adjustable regulator for propane is similar to the 7000 series on the next page. This regulator has twice the capacity of the smaller one with a rating of 3,000,000 Btu's. Range:0-30 psi. 1.4" inlet and outlet. UL Listed

Price: \$57.95

Price: with 0-30 gauge \$66.50



8



**High Pressure Adjustable Regulator**

The 7000 series regulator is an adjustable regulator with a range of 0-30 PSI. It can deliver up to a maximum of 1,500,000 BTUs. It has an inlet and outlet size of 1/4" NPT. The regulator can be equipped with a 0-30 PSI gauge for reading the delivered pressure. UL listed.



Price: \$44.50  
W/Gauge: \$ 53.95

**Propane Hose**

These 1/4" ID propane hoses are rated @ 1750 psi burst pressure and 350 psi operating pressure. All hoses come with 3/8" swivel female flare fittings. Ideal for high pressure propane.

Length:	2'	3'	4'	5'	6'	8'	10'	12'	over 12'
Price:	\$ 12.50	14.95	17.95	20.95	24.50	30.95	36.95	42.95	add \$3.25 per/ft

**Flexible Gas Connector**



DORMONT MFG. CO.

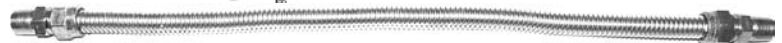

These CSA approved connectors make hookup to gas supply a snap. We carry the large size (1/2" interior diameter) to allow large volume, low pressure gas hookup. One end has a 1/2" male pipe connection, the other a 1/2" female pipe connection. Stainless Steel construction.

24"	\$23.50	36"	\$27.50	48"	\$32.50
-----	---------	-----	---------	-----	---------

**Gas Cocks**

Gas cocks provide 100% positive shut off to downstream units. These forged brass body valves feature smooth quarter turn operation. The chrome plated ball is self cleaning. The special seats will seal at both high and low pressures. CSA approved.



1/2" Price: \$ 7.95 Price: 3/4" Price: \$ 9.95

**Ball Valves**



These full port ball valves (on the left) are CSA & UL approved. They provide smooth control with the ability to handle full flow amounts. Available in sizes up to 4". The full port valves (on the right) feature the same characteristics, but can be locked out in either open or closed positions.



*Lock not included*

1/2" Price: \$12.95  
3/4" Price: \$17.95

1/2" Price: \$24.95  
3/4" Price: \$29.95

**Needle Valves**













Needle Valves provide smooth, precise control for burner operation. They will not "wobble" or change position during the firing. A must if you really need to "fine tune" your burners. Rated to 400psi WOG.(water, oil, gas). NOTE: though not specifically CSA approved for fuel gases, many local agencies accept needle valves for such use.



1/2" Price: \$42.95  
3/4" Price: \$49.95

**Brass Fittings**

Listed below are the most widely used fittings for gas fired burner systems. If you don't see what you need or don't know what goes with what, feel free to give us a call to discuss your application. **We carry many more fittings than those pictured.**

 <p><b>Male Flare to Male Pipe</b>                  1/4" male pipe x 3/8 flare \$2.15                  3/8" male pipe x 3/8 flare \$2.35                  1/2" male pipe x 3/8 flare \$2.55</p>	<p><b>Female Pipe to Male Flare</b>                  1/4" female pipe x 3/8 flare \$2.15                  3/8" female pipe x 3/8 flare \$2.35                  1/2" female pipe x 3/8 flare \$2.55</p> 
 <p><b>Full Union Male to Male</b>                  3/8" male flare \$3.25</p>	<p>3/8" flare nut \$.95      Flare Nut                  1/4" flare nut \$.85</p> 
 <p><b>Swivel nut connector • Female</b>                  3/8 female flare \$4.50</p>	<p><b>Pipe to Male Flare 90°</b>                  1/8" male pipe x 1/4" flare \$2.75                  1/8" female pipe x 1/4" flare \$2.75</p> 
 <p><b>Male Flare "T" 3/8 flare</b> \$5.95</p>	<p><b>Male Flare Cross 3/8 flare</b> \$6.95</p> 
 <p><b>90° Truck Valve (compression or flare)</b>                  1/8" male pipe x 1/4": \$10.95</p>	<p><b>Female Pipe to Compression</b>                  1/8" female pipe x 1/4"OD \$3.25</p> 
 <p><b>Straight Compression Needle Valve</b>                  1/4"OD x 1/4"OD: \$8.50</p>	<p><b>POL Tank adapter with hand wheel</b>                  POL x 1/4" male pipe: \$8.50</p> 

**Quick Connectors**

Pipe Size	Price	Quick connectors allow rapid connection of gas lines. These fittings are "full port", allowing low pressure gases to be used without flow restrictions. Note: These valves DO NOT provide shutoff when disconnected. Shutoff valves MUST be upstream. Both parts in set with female pipe fittings.
1/2"	37.50	
3/4"	52.50	
1"	63.50	



**Pipe Clamps**



Pipe Clamps can be used to hold burners or connect Ransome type burners to larger burners when used in tandem. All clamps accept a 3/8 threaded rod except the 2 1/2" size which uses a 1/2" rod.

1/2"	\$5.95
3/4"	6.45
1"	6.95
1 1/4"	8.95
1 1/2"	11.45
2"	15.75
2 1/2"	22.25

These clamps come preassembled and hold the Ransome Piggyback Pilots to the main burner.

**Pilot Clamps**

2" x 1/2"	Price: \$24.50
2 1/2" x 1/2"	Price: \$32.50





**Analog Pyrometer**

This large (4.5" x 4") meter is great for easy temperature checks. It comes with a 12" or 5" thermocouple, 3' of extension wire, and a mounting bracket that allows for either horizontal or vertical mounting. Complete instructions come with this meter which is guaranteed for 1 year. It has both Centigrade & Fahrenheit scales.

Price: \$98.50

**Indicating Kiln Shutoff/Soak Model 103**

The Model 103 Automatic Shutoff is a shutoff device with temperature indicator. This simple to use control features a large dial to set your shutoff or soak temperature. It comes with a 12" thermocouple, 3 ft. of extension wire, and mounting brackets. It can be wired for either 120 or 240 volts. It is unaffected by wire resistance as is the analog pyrometer above. It is fail-safe ( kiln shutdown occurs if the thermocouple burns out).



Price: \$ 259.00      Extra Extension Wire    \$ 1.85 per foot

**Prewired Shutoff/Soak Unit**

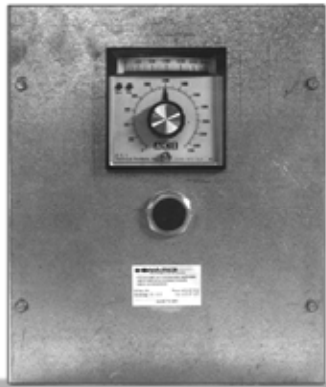

We will prewire the Model 101 or Model 103 Shutoff/Soak Controllers shown above and mount it in a UL approved box. Simply hook up power to the unit and plug in your burners or electric kiln to the unit. It can be wired for either 120V or 240V. Included is the contactor, thermocouple, and an on-off or reset switch, depending on function.

Price: \$789.00

**Computer Controller**

The GB1 Controller is a Microprocessor based controller that can store 10 different user defined profiles with up to 99 hours and 15 setpoints per profile. Output from the controller to gas solenoids can effectively ramp burners up and down according to your needs.

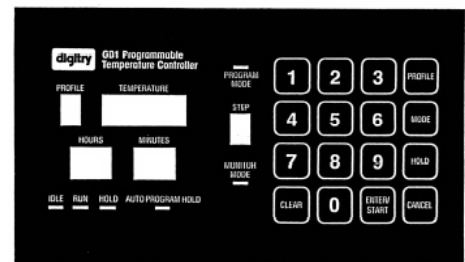

Price: \$799.00

**Digital Pyrometer**

This reliable and accurate digital pyrometer is perfect for Raku or other applications where an instant temperature measurement below the maximum reading of 1999°F is needed. User can select resolution between temperatures displayed in whole degrees or 1/10's of a degree. Readings can also be selected between Centigrade or Fahrenheit. The unit comes with plug-in connectors and 3' of wire. Thermocouples and additional wire sold separately (below).

LT100



Price: \$139.00

**High Temp. Digital Pyrometers**

HT100



Price: \$199.00

These digital pyrometers provides instant and accurate temperature readings in Centigrade or Fahrenheit. Know instantly if you're gaining or losing temperature. The HF-2 has dual inputs and a temperature differential reading function. The HF-1 has a single input.. Both pyrometers are powered by a user replaceable 9 volt battery and feature a shock-absorbing cover and built in stand. The units come with plug-in connectors and 3' of wire. Thermocouples sold separately (below). With extra connectors, wire, and thermocouples, different zone measurements are virtually unlimited. Maximum temperature: 2498°F.

HT200



Price: \$219.00

**Additional Thermocouple Wire**  
 1-100ft \$ 1.85 per ft. >100.... call

This heavy duty thermocouple is easy to install and hook up. Good for all types of firings. For extended thermocouple life in salt and wood kilns, we recommend the optional protection tube.

**Type K Thermocouples**



12" Thermocouple \$27.50

5" thermocouple \$27.50

Protection Tube \$29.50

**Mini K Connectors**



These connectors are the same type that plug into the Digital Pyrometers. With these and additional wire and thermocouples, you can create as many measured zones in a kiln as you want. They're especially great for wood kilns. Each connector has a labeling window to identify your zone. Simply plug in and measure.

Mini K Male Connector \$ 7.50

Wire 1-100ft \$ 1.85 per ft. >100ft. call



BASO Gas Products LLC

Call for other Johnson Controls & Baso Gas Products not pictured

BASO™

**100% Shutoff for Low Pressure • To 14" Water Column**

Control shuts off both main & pilot gas. Pilot gas is taken from within the control. Pilot activated by reset button. All fuel gases.

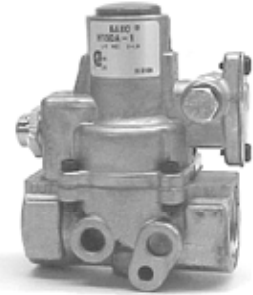

H15DA... \$ 144.50  
H15FA... \$ 214.50

MODEL NUMBER	INLET & OUTLET FEMALE NPT	PILOT TAP IN.	NATURAL GAS CAPACITY BTU/HR @ 1" P.D.	DIMENSIONS (INCHES)			THERMOCOUPLE	SHIP WGT. LBS
				FACE TO FACE	MAXIMUM WIDTH	MAX. HEIGHT		
H15DA-3	3/4 INCH*	1/8" FNPT	402,000	3 12/32	1 15/16	3 15/16	K15D, K19, K16	0.7
H15FA-1	1 INCH	1/8" FNPT	740,000	3 1/2	2 11/16	4 5/8	K15D, K19, K16	0.8

BASO™

**100% Shutoff for High Pressure**

High pressure design allows use on gas pressures up to 25 PSI. Pilot gas is taken from within the control. Gas will pass to both pilot and main burner when reset button is depressed (H19RA). Gas will not pass to the main burner equipped with flow interrupter (H19NA) when reset button is depressed. Loss of signal from thermocouple shuts off both main and pilot burners.



H19RA - \$ 179.50  
H19NA - \$ 199.00

MODEL NUMBER	INLET & OUTLET FEMALE NPT	PILOT TAP IN.	DIMENSIONS (INCHES)			THERMOCOUPLE	SHIP WGT. LBS
			FACE TO FACE	MAXIMUM WIDTH	MAX. HEIGHT		
H19RA-2	3/8 IN.	1/8" FNPT	2 5/16	1 5/8	4 13/32	K15D, K19, K16	0.8
H19NA-2	3/8 IN.	1/8" FNPT	2 5/16	1 5/8	4 13/32	K15D, K19, K16	0.8

**H91 Series Basotrol™ Electric Solenoid Valve**

These electrically operated valves are for use with all low pressure fuel gases. Current failure closes valve. Valves have two 30" lead wires & conduit connection. Two pilot taps, one on each side of valve.



Price: \$ 109.50

MODEL NUMBER	INLET & OUTLET FEMALE NPT	PILOT TAP IN.	NATURAL GAS CAPACITY BTU/HR @ 1" P.D.	DIMENSIONS (INCHES)			VOLTS AC 60 HZ	AMP RATING	SHIP WGT. LBS
				FACE TO FACE	MAXIMUM WIDTH	MAX. HEIGHT			
H91RA-4C	3/4 IN.	1/8" FNPT	420,000	3	1 27/32	4	120	0.1	1.5

**NOTE: Call for other available sizes, voltages, & pressures**

**Husky™ K16 High Performance Thermocouple**

This Heavy duty, high performance thermocouple provides high output for residential, commercial, and industrial applications. The "HUSKY™" is a replacement for BASO 17D, 50, 58D, 87D, 88D, 97D, 107D, and K15 thermocouples.

36 inches long • Millivolt range: 25-35mV \$13.95  
72 inches long • Millivolt range: 25-35mV \$39.95



**Flame Retention Nozzles**



"AN" type nozzles are open flame heads designed for high capacities with good flame retention characteristics. High capacities are made possible by large burner area in relation to flame tube size. "AN" nozzles are scientifically designed to handle rich gas-air mixtures while using relatively low mixture pressures. Drilled pilot holes around the opening keep the main flame from "blowing off" the burner nozzle. Increases in flame actually improve the piloting action. Other sizes than those listed are available. Please call for additional sizes and price. Sizes apply to the thread size of pipe that the nozzle is screwed onto. See the bottom of page 13 for pipe sizing information.

Size	Price
1 1/2"	\$69.50
2"	\$78.50
2 1/2"	\$89.50

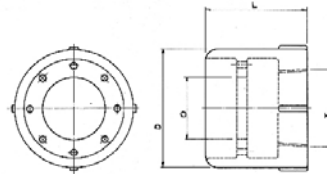

SIZE	Burner Area SQ. IN.	"T" Pipe Size	"D" Diameter	"L" Length	"O" Port Opening
2"	2.90	2"	3 1/4"	2 7/16"	1 7/8"
2 1/2"	4.20	2 1/2"	3 7/8"	2 3/4"	2 1/2"

**Continuous Duty Blowers**



MODEL	HP	VOLT	MOUNTING DIMEN.			OUTLET OPENING		RPM	FREE AIR CFM	PRICE
			H	W	D	H	W			
60	1/25	115	2 13/16	2 3/8	9/32	2 1/8		3030	60	\$ 102.75
100	1/70	115	SAME AS ABOVE			2 1/8		2870	100	\$ 115.50
140	1/30	115	1 1/2	4 1/8	9/32	2 1/2	2 1/2	3020	140	\$ 119.95

These shaded pole blowers, finished in grey enamel, are reliable continuous duty blowers for use with forced air burners. We use these same blowers on our MB Power Burners. All blowers are for use with 115 volts. They have thermal shutoff protection, but are not affected by normal port temperatures because they are self cooling. Blowers come with two lead wires and must be grounded for safety. These blowers are direct drive and can be mounted in any position. NOTE: Only the Model 60 comes with an inlet cover.



**H.O. Tretrice Co.**

**Range Price**

0-15"wc	\$57.25
0-60"wc	\$57.25
0-100"wc	\$57.25
0-5 psi	\$57.25
0-10 psi	\$57.25
0-15 psi	\$22.50
0-30 psi	\$9.50

please call for prices on other pressure ranges.

We carry a full range of pressure gauges for your kiln or furnace. To help you understand what gauges do and don't do, here's a short explanation;

Gauges that we carry fall into two types: Diaphragm and Bourdon Tube. Diaphragm gauges are more sensitive and delicate. They are used to measure lower pressures (up to 10 PSI). The definition of low pressure, though, is anything under 1 PSI (pounds per sq. inch). When using pressures below 1 PSI, the scale of Water Column inches is used (WC). There are 27.7" WC in 1 PSI. Most Natural Gas is delivered at 7"WC while 11"WC is a common propane delivery pressure. There are three different types of pressure readings; Gauge or Differential, Pressure Drop, and Manifold. Depending on the location of the gauge, you will get one of these types of readings all of which can be different. Gauge Pressure varies depending on orifice size. It is a reference number only and does not actually measure flow. Manifold pressure is the pressure used to determine orifice sizing and BTU output.

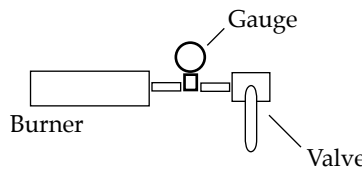

**Gauge Pressure**

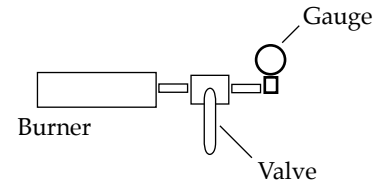

**Manifold Pressure w/valve closed  
Pressure drop w/ valve open**

**Pipe Sizing Charts**

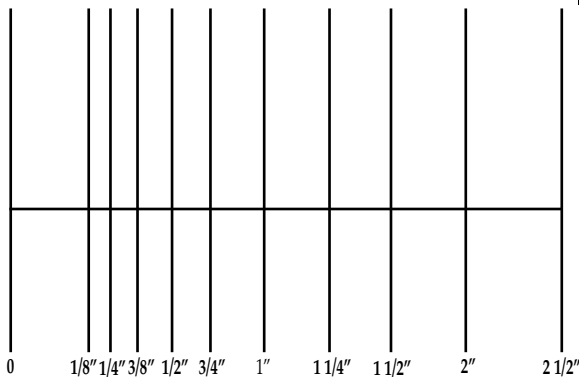

**Note: When printing this page, turn off "scaling" in your printer dialog box to preserve accuracy.**

Pipe size can be confusing. A one inch pipe is neither exactly 1" on the inside or outside. A 1/4" pipe is close to 1/2" on the outside. We provide our customers with these charts to make it simple. To determine what pipe size you have on the outside use the chart on the left. Place the center of the pipe on the horizontal line and read the correct size.

For measuring the correct size of a female fitting, place the center of the pipe under the edge of the bottom of this page and measure across the center of the opening. For ease of measuring, fold page up so lines come to the page bottom.

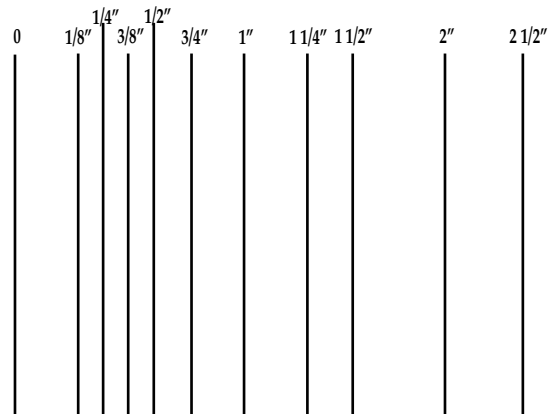
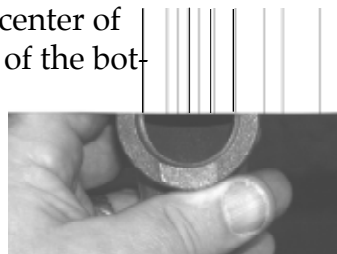

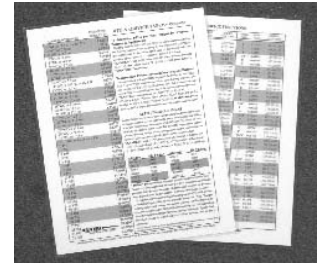

We've taken something as complicated as this:

$$V \cdot \left(\frac{X}{Y}\right)^2 \cdot \Pi \cdot \bar{K} \cdot 1655 \cdot \sqrt{\frac{H}{G} \cdot \frac{\bar{K} \cdot \sqrt{2g} \cdot A2 \cdot \sqrt{p2 \cdot \Delta P2}}{\bar{K} \cdot \sqrt{2g} \cdot A1 \cdot \sqrt{p1 \cdot \Delta P1}}} = \text{BTU/Hr}$$

and made it as simple as this:

$$a \cdot b \cdot c = \text{BTU/Hr}$$

We've taken, what for many, was guess work and made it as simple as 1-2-3. By using our charts for Natural Gas and Propane (LP), you can quickly and easily determine the BTU output of your burners, know what size orifice to drill, and know the effects of altitude.

Charts are screen printed in two colors on heavy card stock, then laminated with 10mil plastic on both sides, and edge sealed. Made to take abuse and last. To determine BTU's per Hour: Multiply Pressure Function by Orifice Function. To determine Orifice Size: Divide known or desired BTU's/Hr by Pressure Function, then match up your Orifice Size. Altitude effects are determined by multiplying your answers by the Altitude Function. Please specify either Natural Gas or Propane.

These Charts Provide:

Price: \$ 18.50

49 Different Pressures • from 4"wc to 25 psi

Altitude Adjustments • from Sea Level to 11,000 ft.

137 Different Orifice Sizes in Fractions, Numbered, and Lettered • from #80 to 1/2"

Over 73,000 Different Combinations

Price: Blank \$ 5.00  
 Drilled \$ 7.50

## Orifice Plugs

We carry four different orifice plugs. **Type A:** fits Ransome B-3 thru B-5, 7/16" x 27. **Type B:** fits Ransome Pilot burners, 1/4" x 28. **Type C:** fits MR750 & MR100 burners, 11/32 x 32. **Type D:** fits our MB series burners, 1/4" npt.

## Orifice Spuds

So, you just dropped your Venturi Burner right on the brass part sticking outa' the back of the burner...it's busted, now what? We carry replacement orifice spuds (also called mixer pins), for the burners we sell. Or use these, along with our orifice chart, to build your own burners. Price includes sizing and orifice drilling

Ransome Piggyback Pilots.



Price: \$19.50

1/8" pipe connection

Ward Burners (MB Series)



Price: \$21.50

1/2" pipe connection

GACO Burners



Price: \$21.50

1/2" pipe connection

Ransome Burners



Price: \$21.50

1/2" pipe connection



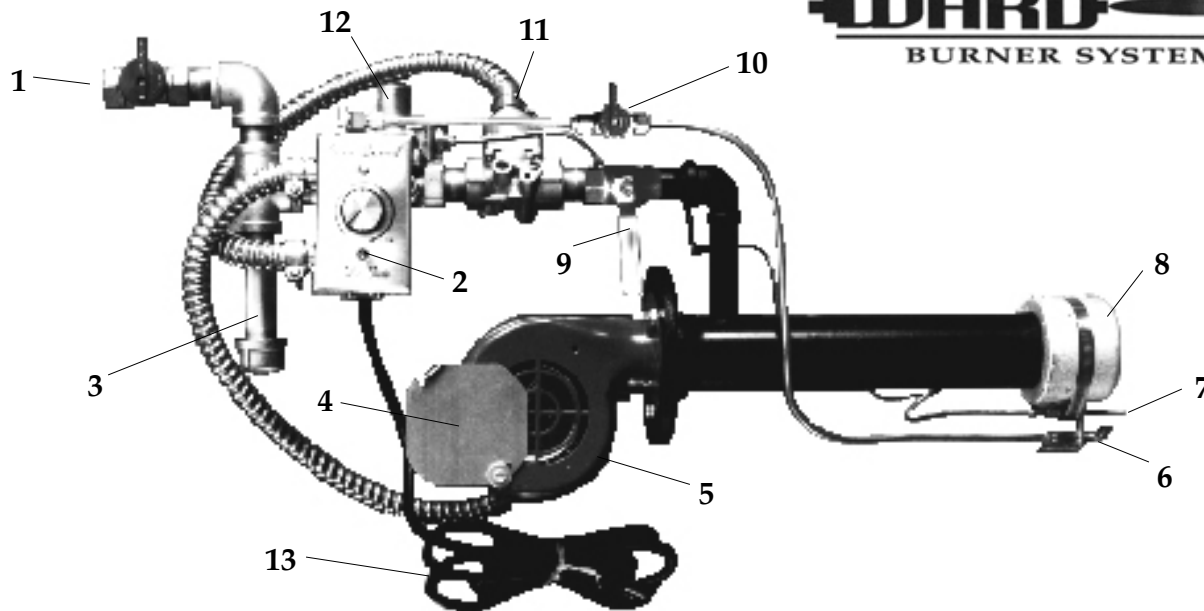

**MB 300 with Optional Electric Solenoid**

Our **Power Burners** are forced air burners that have several advantages over Venturi burners. Since air and gas are independently controlled, then mixed, these burners are very efficient. The high volume, long flame length helps produce quicker, more efficient firings. Power burners, with their forced air, do not depend upon the chimney to provide draft. Chimneys need only be tall enough to remove the flue gases from the kiln shed or building. Working on low pressure, **Power Burners** can be used with either propane or natural gas. These burners are designed to deliver high output on low pressures (14"WC or less). The Btu figures at right are based on natural gas delivery @ 7"WC with .65 specific gravity and propane delivery @ 11"WC with 1.522 specific gravity. Orifices can be adjusted to deal with a wide range of low pressures.

A brass gas cock (1), provides 100% shutoff. Air is controlled by the variable speed control (2) and the manual air shutter (4) and provided by the continuous duty blower (5). A sediment trap (3) prevents sediment from passing through the gas train. The BASO™ valve (12) is connected to the pilot burner (6) which can be adjusted by the CSA/UL approved gas cock (10). The pilot energizes the thermocouple (7) and ignites the main flame which is held constant by the flame retention nozzle (8). An CSA/UL approved ball valve provides smooth gas flow adjustment (9). An optional electric solenoid valve (11) provides instant shutoff in the event of power failure. Electrical connection is by a grounded 6' cord (13).

**Please Note:** These burners are **custom made** for your application. Even though we stock all parts, they are **not** "off the shelf" items. Delivery times usually run from **2 to 4** weeks. Please plan accordingly.

**Definitely Note:** Different burners require different port & flue sizes. Please check with us to help determine your burner needs and sizes **before** you begin construction.

Due to continuing improvements, we reserve the right to change specifications without notice

**NOTE:** The Target Pilot burner that comes standard with all Power Burners, energizes the thermocouple and BASO™ valve, then ignites the main flame front. It is not intended as a preheat burner and can be adversely affected by windy conditions or excessive back-pressure. If any of these conditions are a concern, we strongly recommend the use of one of the optional piggyback Venturi burners listed below.

Burner Model	Blower CFM (Cu.ft. / Min.)	BTU/Hr Nat. Gas @ 7"wc	BTU/Hr Propane @ 11"wc	Price
MB200	60	213,000	246,000	\$879.00
MB300	100	333,000	335,000	\$899.00
MB400	100	441,000	437,000	\$899.00
MB500	140	563,000	553,000	\$919.00
MB600	140	653,000	683,000	\$919.00
MB700	140	750,000	753,000	\$919.00

The equipment listed below is optional. The prices below are the installed prices in addition to the burner base price listed above. For your burner price, add the base price (above) plus any optional equipment.

### Optional Equipment

**Electric Solenoid Valve.** This valve provides instant shutoff in the event of power failure. Flame may lick up the outside of the kiln or go back into the blower during a power outage if this valve is not present. Mounted downstream of BASO; shuts down main burner but leaves pilot burning for automatic reignition upon re-establishment of electricity. Mounted upstream of BASO; shuts down both main and pilot burners with loss of current, calling for manual re-lighting.

**Price: \$149.00**

**Water Column Gauge** This gauge helps produce repeatable firings by providing a reference point based on differential pressure or pressure drop depending on valve location in relation to flow control valve.

**Price: \$59.50**

**Ransome Piggyback Venturi Burner.** This Venturi pilot burner is excellent for overnight warming and windy areas. Power Burners may not be able to provide the very low settings needed for the start of bisque firings. This optional pilot can provide several thousand Btu's of heat to completely dry out the load. Comes with attaching clamp, large oval head, baffle plate, gas cock, supply line, and thermocouple fitting. 2,000 to 4,000 Btu output.

**Price: \$189.00**

**MR750 Piggyback Venturi Burner.** This Venturi burner makes an excellent pilot for salt and large kilns that also bisque. Provides higher BTU output than the Ransome Pilot, though not as good in windy conditions. May not be suitable for all kilns. Requires larger port, flue, and chimney sizes.

**Price: \$135.00**

**Spark Ignition.** Spark ignition provides an additional level of safety and convenience. Flip a switch and the transformer produces a very intense spark at 300 pulses a minute. Upon pilot ignition, sparking stops. If there is a pilot outage, the electrode senses this in less than 1 second and reignites the pilot. Safe, Fast, Easy.

**Price: \$179.00**

**Adjustable Burner Stand.** This burner stand securely holds the burner parallel to the floor and can be rotated 360° or adjusted vertically. Two height ranges measured from the center of the main burner nozzle.

**Short: 15" - 24" Tall: 24" - 39"**

**Price: \$189.00**

**90° Burner Head.** Used when space is at a premium. Allows the burner to be kept close to the wall of the kiln. See page 19 for configurations.

**MB200 thru MB400 Price: \$29.50**

**MB500 thru MB700 Price: \$58.50**

**220 Volt Conversion.** For our customers who do not use 110-120 Volts. Because of the wide variety of male/female plug types in use around the world, the power cord will come without male plug.

**Price: \$79.00**

**Needle Valve.** For those that want very precise control of the main burner. These valves are rated to 400 psi WOG (water, oil, gas) and provide smooth, precise, and incremental throttling of the main burner.

**Price: \$49.95**

# Power Burner Configurations

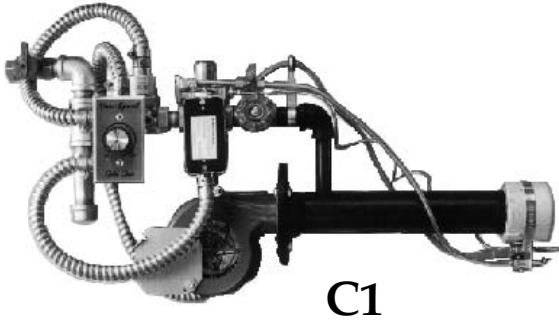

C1

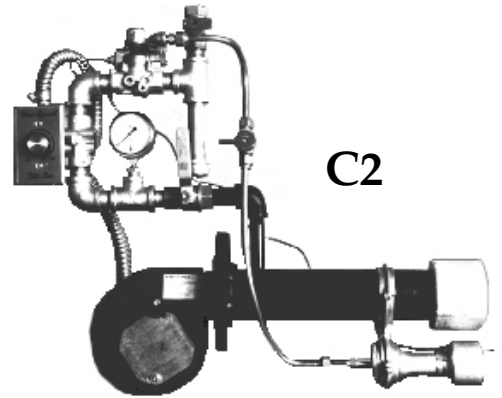

C2



C3

\$25.00 shipping up-charge per burner

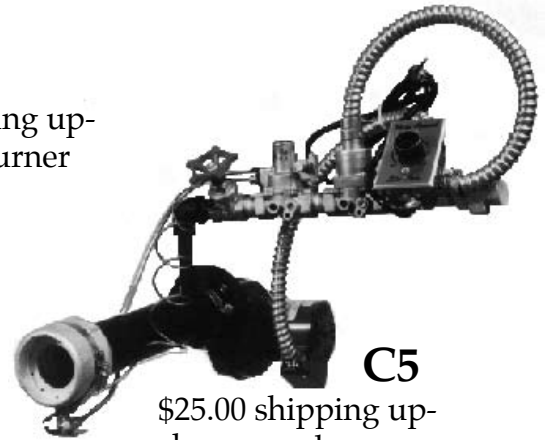

C5

\$25.00 shipping up-charge per burner

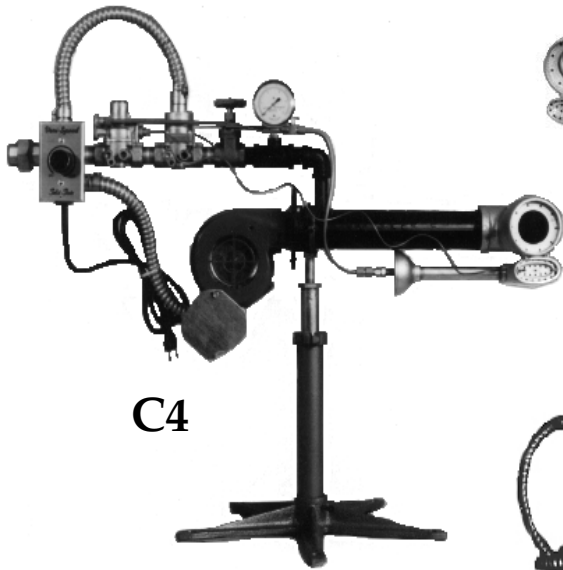

C4

You Must Read Page 33 Before Ordering Burners



C6

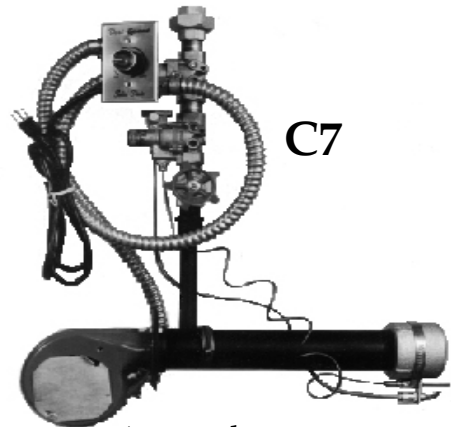

C7

\$25.00 shipping up-charge per burner

If you do not specify a configuration for your burner(s), they will be built in the C1 style. To order one of the configurations above, add C and the number. Example; 2- MB200C6. NOTE: Pairs of burners are built as mirror images of each other.

# Ransome Venturi Burners



You must read page 33 before ordering burners!

**B-4 with Optional Piggyback Pilot, Baso™ System, & Needle Valve**

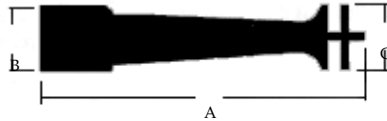

Model	diam. inches			btu/NG 7"WC	BTU/Propane						Wgt. lbs.	Price
	A	B	C		11" WC	1 P.S.I.	2 P.S.I.	5 P.S.I.	10 P.S.I.	20 P.S.I.		
<b>B-1</b>	8	1.38	1.85	5,500	5,900	9,700	13,900	21,600	30,700	43,000	3	<b>\$139.00</b>
<b>B-2</b>	11	2.25	2.75	13,900	9,000	14,800	20,900	33,200	46,700	66,400	5	<b>\$190.00</b>
<b>B-3</b>	12	3.25	2.75	41,600	34,200	55,300	77,500	123,000	175,900	246,000	8	<b>\$205.00</b>
<b>B-4</b>	17	3.75	3.5	67,800	55,300	89,800	126,700	200,500	286,600	403,400	10	<b>\$219.00</b>
<b>B-5</b>	21	5	4.12	81,600	89,800	145,200	205,400	324,700	462,400	649,400	16	<b>\$365.00</b>

**NOTE:** The Target Pilot burner energizes the thermocouple and BASO™ valve, then ignites the main flame front. It is not intended as a preheat burner and can be adversely affected by windy conditions or excessive back-pressure. If any of these conditions are a concern, we *strongly* recommend the use of the optional Piggyback Venturi burner listed below.

The equipment listed below is optional. The prices below are the installed prices in addition to the burner base price listed above.

### Optional Equipment

**BASO™ Safety System.** This safety system comes with thermocouple, gas supply line, fittings, pilot valve, and a pilot burner. Price includes attachment to your burner. Price of the installed safety system is dependent on the type of pilot you chose. The pilot pictured above is the Piggyback Pilot. A target pilot is pictured on the MB 300 on pg.17. The prices below are in *addition* to the price of the burners above.

**Installed Price with target pilot (low pressure): \$259.00    Installed Price with Piggyback Pilot (low pressure): \$ 369.00    Installed Price with Piggyback Pilot (high pressure): \$ 389.00**

**Piggyback Venturi Pilot.** This small burner attaches to the head of all our Venturi and Power Burners. It is drilled and tapped to accept a "through the head" thermocouple. This burner is perfect for overnight warming or for windy locations. BTU output ranges between 2,000 & 6,000, depending on gas and pressure. Pictured installed on B-4 at the top of the page.

**Installed Price (on Venturis without BASO): \$159.50    Unattached Price: \$149.00**

**90° Angled Head.** Allows the burner to be mounted for side, up, or down firing. This head will double the "B" measurement in the above chart.

**Price: \$20.00 per burner**

**Giberson Ceramic Burner Head.** These patented ceramic burner heads are practically corrosion-proof. They are great for salt kilns and glass furnaces.

**Price if sold separtly \$185.00    In place of Ransome head \$150.00**

**1/2" Needle Valves.** For very precise control of the main gas.

**Price: \$42.95**

The **MR750** is an affordable and compact Venturi burner suitable for high fire kilns, furnaces, or Raku kilns. It features flame retention within a one piece design. It is rated at 77,400 BTUs operating on propane @ 11" WC. Natural gas @ 7" WC produces 78,440 BTUs. The **MR100** is slightly larger than the MR750. It produces 94,000 BTUs on propane and 90,675 BTUs with natural gas. Be aware that these BTU figures are based on set orifice sizes provided by the manufacturer. We calculate and drill our own orifices. Other sellers of these burners are usually not able to advise on or provide you with proper orifice sizes. If you are using high pressure propane (1 PSI or above), which is a popular choice in Raku kilns, you will need a nonstandard orifice.

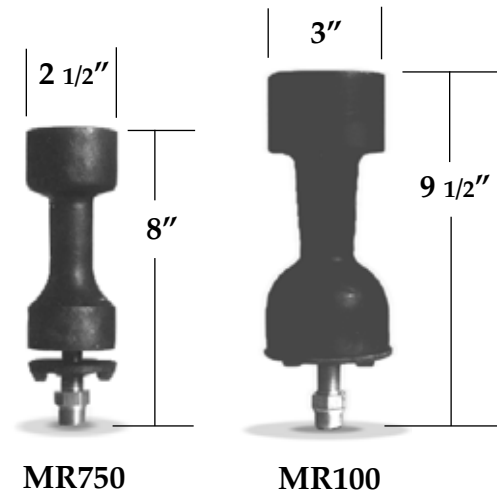

MR750..... \$ 59.95

MR100..... \$ 72.95

Model	BTU/NG		BTU/Propane						
	7"	11"	2psi	3psi	4psi	5psi	10psi	15psi	20psi
MR750	78,440	77,400	76,880	94,500	109,250	122,100	171,910	210,555	243,130
MR100	90,675	94,000	97,650	118,850	137,250	153,500	216,110	264,690	305,640

**BASO™ Safety System.** This safety system comes with thermocouple, gas supply line, compression fittings, pilot valve, and a pilot burner. Price includes attachment to your burner. Price of the installed safety system is dependent on the type of pilot you chose. The pilot pictured below is the target pilot. The piggyback pilot is pictured on the next page and also on pg.20. Prices below are in *addition* to the price of the burners above.

- Installed Price with target pilot (low pressure): \$259.00
- Installed Price with Piggyback Pilot (low pressure): \$ 369.00
- Installed Price with Piggyback Pilot (high pressure): \$ 389.00

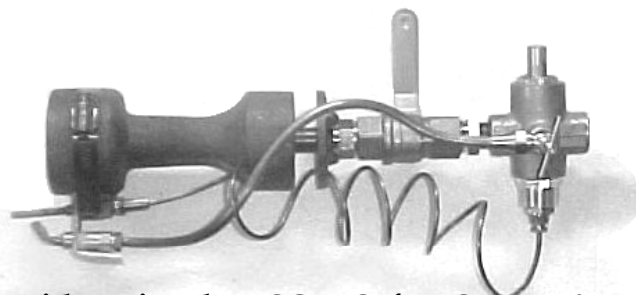

MR750 with optional BASO™ Safety System & Target Pilot

**NOTE:** The Target Pilot burner energizes the thermocouple and BASO™ valve, then ignites the main flame front. It is not intended as a preheat burner and can be adversely affected by windy conditions, high delivery pressures, excessive back-pressure, or reduction atmospheres. If any of these conditions are a concern, we strongly recommend the use of one of the optional Piggyback Venturi burners listed above.

## Rectified Power Burners

Rectification is a type of flame safety that does not rely on the more traditional thermocouple and Baso valve safety. It combines spark ignition, an intermittent pilot, and flame rod to ignite, prove and monitor the flame. Burners are turned on and off with a simple throw of the switch or by controllers. Flame proof and safety shutdown are accomplished in less than 1 second. Feel free to give us a call to discuss the advantages of Flame Rectification.

- Safer
- Quicker Response
- Totally Electronic
- No Thermocouple Burnouts



Rectified Power Burner Prices

MBR200	150,000 - 275,000 Btu/Hr	\$2299.00
MBR400	285,000 - 480,000 Btu/Hr	\$2329.00
MBR700	500,000 - 750,000 Btu/Hr	\$2379.00

specific Btu outputs are set to your individual requirements

All of the Venturi Burners we carry can be equipped with rectification. While the Power Burners above always operate on low pressure (< 1/2psi), Venturi burners can operate on a wide range of pressures from low to 25psi. Pricing is based on the Venturi burner used along with the range of pressure to be employed. Rectification can provide for remote electronic control and safer, more reliable monitoring. Please call for pricing based on burner, gas pressure, and pilot.



MR750 with Rectification. Not shown, but included is the Intermittent Pilot control and 24Vac transformer. **Pricing based on configuration. Please Call for specific prices.**

**Raku Systems**



**MR750 Single Burner System**

The **MR750 & MR100 Raku Systems** feature the **MR750 & MR100** Venturi burners, gas cock, 12ft-350psi hose, 0-30psi adjustable regulator, 0-30psi gauge, and POL tank adapter with hand wheel. With 1-8 PSI, the MR750 Single System is rated at 54,365 to 153,768 BTU's, the MR100 is rated at 68,347 to 193,303 BTU's. The Dual systems use two burners, two gas cocks, two 12' hoses, which are connected to the regulator/gauge. The output of the dual systems is double the values above.

- MR750 Single Burner System: \$209.00**
- MR100 Single Burner System: \$219.00**
- MR750 Dual Burner System: \$289.00**
- MR100 Dual Burner System: \$299.00**

All Raku systems can be equipped with: **BASO™ Safety Valves with windproof pilot \$ 389.00**

The **Ransome B-3 Raku System** is an efficient and easy to operate system. It features; **B-3 Ransome** Venturi burner, gas cock, 12ft-350psi hose, 0-30psi adjustable regulator, 0-30psi gauge, and POL tank adapter with hand wheel. Rated at 55,000 to 250,000 BTUs with 1 to 20 psi. With an adequate fuel source, the dual system is capable of firing a stoneware kiln up to 50 cu/ft .

- B-3 Single Burner System: \$355.00**
- B-3 Dual Burner System: \$589.00**



**B-3 Single Burner System**



**B-3 Single Burner System (detail)  
Equipped with BASO™ Safety Valve & Windproof Pilot**



**B-3 Dual Burner System**

When ordering a complete Raku system, you do not need to know your gas & pressure. These systems are for propane (LP) only. They come with a regulator that allows you to adjust the pressure. They are designed to hook directly to any size propane cylinder with a POL or Acme tank valve.

# Propane Tanks, Connectors, & Tongs

Larger capacity propane tanks can extend the time between fill-ups and prevent freeze-ups. Propane tanks can freeze when fuel is withdrawn too rapidly for the tank volume. This can be especially true in the winter while firing Raku kilns with small ( 20lb tanks). The pounds rating on tanks refers to the amount of fuel (in pounds) that the tank holds. The actual full tank weight is greater.

Tank Size	Wt. Full	Price
20 Lb	38	\$35.00
30 Lb	56	\$79.50
40 Lb	70	\$129.50
60 Lb	106	\$199.00



Tank Connectors are used to hook two or three propane tanks together. Not only does this extend Raku firing time, but can help prevent tank freeze up. All of our connectors come with soft-nosed POL tank adapters with hand wheels for tool-free hookup. Two 3 ft. hoses attach to the 2 Tank-Connector. The 3 Tank-Connector features three 3 ft. hoses that allow the use of three tanks (designed to feed from all tanks simultaneously). Both have 1/4" Male fittings for the regulator connection.

- 2-Tank Connector \$58.95
- 3-Tank Connector \$85.50

## Raku Tongs

We offer two types of Raku tongs. Both are made of rust-free plated steel and ideal for most any type of Raku work. The handles are tubular, making them strong and lightweight.

TG 37 - 41" in length 37° Jaw \$44.99

TG 45 - 31" in length 45° Jaw \$42.99

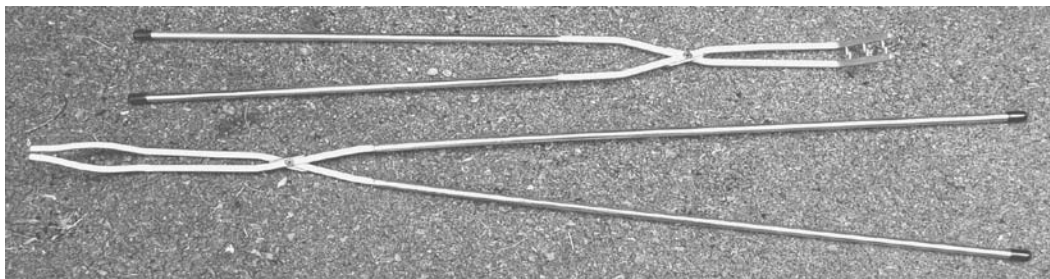



For our customers who want to build their own Raku kiln, we offer two kits. Hey, you can buy nuts and bolts, right? Well, we've designed these kits with that in mind. The stuff you can get at your local hardware store or have in that junk pile, is the material you can easily lay your hands on. You don't need us to ship it across the country to you. These kits provide you with the things that are hard to find. One of the most important things you need to build a ceramic fiber Raku kiln is information. That's why both kits come with Steve Branfman's great book, "Mastering Raku". Steve has clear instructions along with step by step photographs showing you how to build a fiber drum kiln. There's also recipes for clay and glazes along with lots of information on safety, firing procedures, and the history of Raku.

You'll provide a propane tank, the metal mesh for the drum, cinder blocks, nuts & bolts, handles, tools, and, of course, the labor... Don't worry, the book shows you what to buy, how much, what it's called, where to find it, and what tools you'll need. We provide you with;

- *Mastering Raku*
- 2300° 1" Isofrax™ Ceramic Fiber
- 15 gauge High Temperature Wire
- 2300° Insulating Bricks
- Complete Burner System

**Kit #1** This kit provides you with our materials that enables you to build a 3 cubic foot Raku kiln with a drum that is 16" interior diameter and 24" tall.

**Price: \$449.00**

**Kit #2** This kit provides you with our materials that enables you to build a 6 cubic foot Raku kiln with a drum that is 24" interior diameter and 24" tall.

**Price: \$549.00**

add:

Baso Safety System with Ransome Piggyback Pilot **Price: \$389.00**

2 Tank Connector **Price: \$58.95**

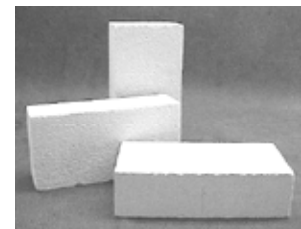
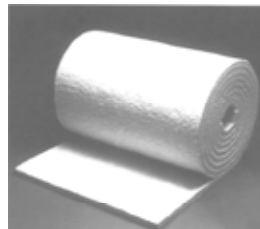

# Glove Descriptions & Prices

**A-Excellent B-Good C-Fair D-Poor**

durability from mechanical wear

durability from temps >1500°F

hand insulation from heat

non-hardening from high heat

handling dexterity

## Glove & Mitt Chart

Zetex	<b>B+</b>	<b>B-</b>	<b>D+</b>	<b>A+</b>	<b>B</b>
ZetexPlus	<b>A</b>	<b>A</b>	<b>B</b>	<b>A+</b>	<b>C-</b>
Leather	<b>B</b>	<b>B</b>	<b>A</b>	<b>C</b>	<b>B+</b>



14" shown



**Zetex™ Glove** Made of UL Listed Zetex fabric. These gloves are full cut to fit the average sized man's hand. UL Listed. Though these gloves insulate well, they are not as durable as leather.

**NOTE:** *These gloves are not suitable for rough work such as wood-firing or heavy raku*

14" \$69.00  
23" \$95.00



**Double Palm Mittens** This is the top-of-the-line extreme heat mitten. If it's glowing hot, you can pick it up with these. (Remember, if you are that close to high heat, the rest of your clothing is at risk!) UL Listed for direct contact up to 2000°F. The money spent on these gloves is for superior heat protection not mechanical wear. If used regularly, overmitts will help protect your mittens and investment from wear.

14" \$119.00  
23" \$155.00



9" \$59.50

**Overmitts** Protect your investment with these Zetex-Plus overmitts that fit over the Double Palm mitten. Covers to the bottom of your palm. Uninsulated. *Not for use with other gloves.*



23" shown

## Leather Gloves

Made to the same rugged specs as our Women's Glove, these insulated gloves are cut fuller for larger sized hands. They feature the same "sock" fit liner that is in the glove above. "Sock" fit liners don't have the seams that other liners have, thus preventing heat seepage through the seams.



14" \$49.00

23" \$65.00



**Aluminized Suits & Components**



Aluminized Zetex fabric outperforms other fabrics

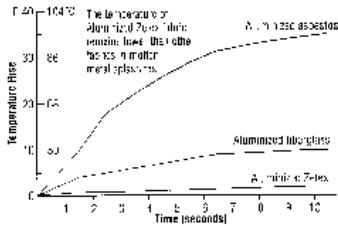

**Hood.** Made from aluminized Zetex with a lift front hood and flame retardant cotton liner. Protects head & shoulders. **Price: \$495.00** with stationary window **Price: \$ 405.00**



for gold film window, add; **\$40.00**

When dealing with large, glowing work or working near large, open furnaces, folks can be subjected to tremendous amounts of radiant heat. Zetex aluminized protective suits & components are UL rated to withstand up to 2000°F radiant heat for this type of working environment. (For direct contact at 2000° see ZetexPlus products on the preceding pages). Feel free to call us to discuss all of your protective clothing needs. Just because it's not on these pages, doesn't mean we don't carry what you're looking for.



Aluminized Zetex safety clothing is made with aluminum film bonded to durable Zetex fabric. These clothes provide excellent heat reflection and resistance to delamination, cracking, and peeling. All clothes are lined with Flame Retardant cotton. Made to last and pretty damn stylish too...

**Pants.** High waist design with an 8 point, all elastic, adjustable suspenders. Snapped triangular storm fly front and snap adjustments at leg bottom.  
**Sm 30-32 Med 34-36 Lg 38-40 XL 42-44 2XL 46-48**

**Price: \$ 295.00** (XLs add 10%)

**Coat.** Tailored sleeves with covered snap adjustment. Lined with FR Cotton. 32 inches in length. When ordering sizes, order the size you normally wear in street clothes. Aluminized clothing is cut large to fit over your street clothes.  
**Sm 30-32 Med 34-36 Lg 38-40 XL 42-44 XXL 46-48**



**Price: \$ 309.00** (XLs add 10%)



**Aluminized Apron.** These bib-style aprons reflect 90% of radiant heat and protects the chest and upper legs from heat wash. 24"wide x 40"long. If you've ever tried to get away from your pants when they're real hot, you'll be needing this...

**Price: \$82.50**

**Complete suit.** This complete suit includes hood (with lift front), coat, pants, gloves (aluminized Zetex with leather palms), shoes, and carrying case. Gold film is included on the face shield at no extra cost. Lined with FR Cotton. If you use this suit to hand-remove Raku ware or handle extremely hot items, we *strongly* recommend substituting the ZetexPlus mittens found on page 28. **S, M, L, XL, XXL** (XLs add 10%)



**Price: \$ 1199.00**

**Economy Face Protector.** This face protector prevents low levels of radiant heat from burning the face, neck, and ears. Perfect for light Raku firing or furnace & kiln viewing. The dark grey face shield is made of polycarbonate for heat resistance and reduced glare. This face shield should only be used in light heat situations. (Raku done in street clothing.) If your heat requirements demand that you use speciality protective clothing, this face shield could warp and sag from higher heat exposures. If this is the case, the face shields below are more appropriate. It has a soft vinyl headband and adjusts from size 6 to 8 1/2 in 1/8 increments. Features a ratcheting adjustment for quick head size adjustment.



**Price: \$32.50**



## 24K Gold Coated Faceshield

This faceshield is made with a coating of pure 24K gold, the best heat reflector you can use. Made for higher heat use than the economy model above, the shield is twice as thick and features a chin guard for extra protection. A must for those exposed to higher levels of heat such as very large Raku kilns and foundry work. Provides excellent UV and IR protection. NOTE: If conditions warrant the use of this faceshield, then protective clothing and hair protection is strongly advised.

**Price: \$119.00**

## 24K Gold Coated Didymium II

With the same 24K Gold coating as the shield above, this Didymium II face shield eliminates the yellow part of the spectrum allowing one to see "through" the flame. Ideal for glass workers doing torch or glory hole work. Wood kiln users are protected from extreme heat while cone viewing in the presence of flame. You'll wonder how you worked without one....

**Price: \$129.00**



## Nomex Flash Hood

**Flash Hood.** Made from Nomex III, this hood is soft, breathable, and washable. Protects facial hair or long hair from sparks and radiant heat that could singe or ignite hair. Also protects ears and neck.

**Price: \$ 58.00**

There are several variables that come into play when choosing burners for a kiln or furnace. Listed below are the facts you need to know before deciding the size (Btu's per Hour) of your burner system.

1. **Total inside volume of the kiln.**
2. **Type of wall construction.**
3. **Maximum temperature you will be reaching.**

**Calculating Kiln Volume**

Kiln volume is usually expressed in Cubic Feet (CF). In a flat top kiln this figure is arrived at by multiplying the interior height (H) by the interior width (W) by the depth or length (L).

**Sprung or Roman arch:  $CF = W \times L \times (\text{Side wall} + 2/3 \text{ of the arch rise})$**

**Catenary arch:  $CF = L \times \text{Arch area} (4/3 H \times 1/2 \text{ Base Width})$**

**Barrel kiln:  $CF = H \times \pi \times R^2$  ( $R^2$  - Radius is 1/2 the diameter x itself) ( $\pi = 3.14$ )**

If you have used inches in the above equations, divide the total by 1728 to convert to Cubic Feet.

**Wall Construction & Temperature**

The type of material and its' insulating values determines how many Btu's per Cubic Feet per Hour (Btu/Cf/Hr), you will need to reach a desired temperature. Below is a simplified chart showing materials, desired temp., and the corresponding Btu/Cf/Hr. There are a host of variables that can affect kiln efficiency. This is a basic guide only.

<b>Construction</b>	<b>Cone 06 BTU/Cf/Hr</b>	<b>Cone 6 BTU/Cf/Hr</b>	<b>Cone 10 BTU/Cf/Hr</b>
9" Hard Fire Brick	12,000 - 17,000	14,000 - 18,500	16,000 - 20,000
9" Insulating Brick	6,000 - 10,000	8,000 - 13,000	10,000 - 16,000
6" Ceramic Fiber	4,000 - 6,000	6,000 - 8,000	7,000 - 10,000

This simple table gives you an idea of how many Btu's per Cubic Feet per Hour you will need. Multiplying this figure by the total Cubic Feet will give you Btu/Hr. Now divide Btu/Hr by the number of burners you plan to use to determine what Btu/Hr rating each burner should have. The numbers above show a range of BTU figures. The highest figure in each range produces a 6-7 hour firing. The lowest figure will produce firings in the 14-18 hour range. I feel it is better to have extra Btu's than not enough. The above is a guide not a guarantee. If you would like us to verify your calculations, please feel free to call or write.

**Raku Construction & Btu Values**

<b>Lining Construction</b>	<b>Btu/Cf/Hr</b>
4 1/2" Hard Brick	70,000
2 1/2" Insulating Brick	40,000
4 1/2" Insulating Brick	30,000
1" Ceramic Fiber	25,000
2" Ceramic Fiber	20,000

Many folks don't realize that Raku kilns have much higher Btu input rates than stoneware kilns. This is because Raku is traditionally done very quickly. For this reason, it is very difficult to bisque fire in a Raku kiln. If you plan on purchasing or making a Raku kiln, please note that you could have problems with steam explosions of the ware if you attempt to use the kiln for bisque. Also, the structural nature of Raku kilns make many of them impractical for use at stoneware temperatures.

*Before ordering or deciding on burners there are two things that you need to know. This knowledge is mandatory for you and for us.*

The two things are; **type of gas & the pressure.**

Now, the type of gas is pretty easy. You are going to be using propane (LP) or Natural Gas (NG) if you reside in North America or most developed Northern Hemisphere countries. If you live elsewhere you might have some butane in the LP.

Here's the part that many folks don't know, but it is very important and you must find out before ordering. **Pressure.** We need to know this to determine what orifice size to put into the burner(s). If you call to order burners and don't know the pressure, we can't ship you a burner. Plain and simple. You've wasted the money of a phone call because we'll have to tell you to find out this information. Now, we know that there are places you can call to order burners and they'll sell you a natural gas burner or a LP burner with no questions asked. These burners are designed to work on a specific pressure. Did this supplier know your pressure? Did they ask? Will this burner work well on another pressure other than the one it was made for? The same burner can have vastly different BTU outputs with changes in pressure and gas (see the Ransome Burner chart on pg. 20).

So, how do you find out your pressure? Ask the gas company. In the case of LP, the pressure is determined by the regulator(s) on the tank and/or line. Ask them what is the "downstream delivery pressure". This can easily be changed, if necessary, with different regulators. Ask the LP supplier; **"What is the lowest and highest delivery pressures that can be delivered to the site?"**

If you have natural gas service, ask the gas company; **What is the "delivery pressure?" and "What is the highest delivery pressure I can get?" and "What is the largest volume meter you can set?"**. You may be able to get higher pressures of natural gas, but this is, many times, restricted by zoning codes. Using gauges that are reading gauge pressures (again see pg.15), to determine your delivery gas pressure, may be inaccurate when dealing with low pressure (anything under 1 psi).

OK, we've asked you to read all of this and some of you may not need to know this stuff... WHAT! It's better to know about this than not. That's why this is at the end. If you are ordering a Raku system, we are providing you with everything, including the regulator, plus, the Raku systems are for propane only. Also, if you are setting a new, large propane tank, we will tell you the pressure(regulator), you need. If you're adapting to a tank that already exists, *you do* need to know the above information. Feel free to call us about burner applications and such, but please have the information (outlined above) handy or we will not be able to give you useful or correct advise.

**Terms:** Orders are prepaid. We accept personal checks, company checks, and money orders. We also accept the following credit cards; Master Card, VISA, American Express, and Discover. Please check with us for additional shipping charges. Schools and institutions may order items on a net 30 basis. No order based on net 30 will be processed or placed in our production schedules until a valid signed purchase order is received. Also all purchase orders that involve burners or burner parts must reference the gas and pressure. See "Specifics" below. Past due invoices will be charged 1.5% per month service charge. COD orders are shipped only through UPS and are charged an additional \$9.50 over the cost of materials and shipping. Power Burners and Raku Kilns are not shipped COD. TN residents add 9.75% sales tax.

**Specifics:** When ordering burners, please include the type of gas that will be used along with the operating pressure. Please read page 30. Without gas and pressure information we cannot fill your order. NOTE: Natural gas hookup involves many variables. The available pressure, length of pipe run and the number of turns, pipe size, and meter capacity all affect the number of BTU's that can be delivered to the burner. Please consult with us if you have any questions.

**Minimum Order:** There is a \$20.00 minimum order. Orders less than this are subject to a \$3.00 handling fee.

**Returns:** Returns are not allowed without permission and are subject to a 25% restocking fee. Be sure of your application before ordering.

**Prices:** We will do our best to hold prices steady, but as many of you know, this is not always possible. Prices are subject to change without notice.

**Special Charges:** We will be glad to be of assistance helping you pass codes and inspections by your local authorities regarding burners and kilns. If custom drawings and or extensive phone conversations are needed, you may be subject to our consultation rate of \$100.00 per hour (minimum \$25.00 charge) .

**Email Requests:** are welcome to receive a catalog. All other requests generally prompt more questions from us. Email is a VERY poor way to discuss technical matters. Please call us with your questions.

• PO Box 1086 • Dandridge, TN 37725 •

Phone: (865) 397-2914

Fax: (865) 397-1253

email: [info@wardburner.com](mailto:info@wardburner.com)  
Online Catalog : [www.wardburner.com](http://www.wardburner.com)

**Shipping:** We ship UPS whenever possible. All products are shipped FOB from Dandridge, TN. We cannot ship UPS to a PO Box. Please provide us with a street address and phone number. If you have any shipping damage, *notify us immediately*. Shipping damage not reported within 10 days, cannot be covered by insurance. Shipping charges and weights are not listed in the catalog. Customized products make standardized weights impractical. Please call or write for shipping charges. Brick is sometimes shipped directly from the brick plant via freight lines. A suitable location for large trucks to deliver is essential. Truck lines are responsible only for delivery of your order and moving it to the tail of the truck. Unloading is your responsibility and may entail the use of a fork lift.

**Delivery Times:** Many of our products are custom made for your order. This means that these products are not "off the shelf" and require sufficient time for production. Delivery can be anywhere from 2-6 weeks depending on our production schedules. Please allow for this in your plans by contacting us early in your project.

**Foreign Orders:** Communication between us and our customers is essential to ensure that the customer receives the proper items for their intended use. Here in the United States, with a shared language, this communication can take many phone calls over the course of weeks. Email and translation issues can make specifying an item very difficult for our foreign customers. Please be patient and allow plenty of time for orders that originate outside the United States,

**Faxes:** Please print or type clearly all information. Please be sure to leave at least a 1/2" border of clean paper around the edge. Please do not use pencil or blue ink

**NOTE:** We will not be liable for any loss or damage that may arise in connection with the use or performance of any item offered for sale in this catalog, including, without limitation, any indirect or consequential damages.

Burners should be installed and used in accordance with Federal, State, and Local codes, rules, and regulations. Only qualified personnel should install or service burners or burner systems. Installation permits to assure compliance with local codes should be obtained from local enforcing agencies. Use the correct gas pressure for the burner, and be sure the fire box and flue are of the proper size before operating.



• PO Box 1086 • Dandridge, TN 37725 •

Phone: (865) 397-2914

Fax: (865) 397-1253

email: [info@wardburner.com](mailto:info@wardburner.com)  
Online Catalog : [www.wardburner.com](http://www.wardburner.com)



The world of kilns, burners, and fuel gases has its own language and terms. Please take a moment to look at the examples and definitions below. It helps speed up a conversation and make sure everyone is “on the same page” when discussing these issues.

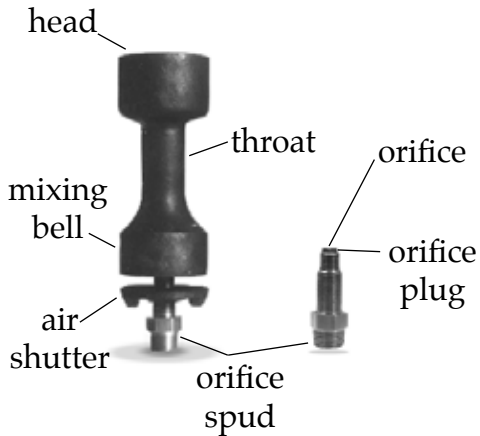

The greatest source of confusion when talking about burners is the orifice. The orifice is the hole that is drilled in the orifice plug. This is where the gas escapes from all your piping and enters the mixing bell of the burner. The orifice is not where the flame comes out of the burner... that’s the head. Orifice plugs are the small nuts (with the hole in them) that are replaceable and screwed into the orifice spud. The orifice spud is the threaded piece that is attached to your piping.

Gauges are instruments that simply report what is happening to the pressure at a specific point in your system under specific conditions. Refer to page 15 for more information. You do not “turn up a gauge”. You turn up valves & burners. The same gauge, in a different location could lower its reading when you turn up the burners. Rely on gauges only to give you a “number” that you can use for repeatability.



Regulators do several things, but in reality they only do one thing: they reduce a higher pressure down to a lower pressure and keep it constant (regulated). Some regulators are adjustable (high pressure) over a wide range of output. These usually have a large knob and/or gauge. Other regulators are “set” regulators that may have a very small range of adjustment. It is mandatory that you know a regulator’s output (in pressure) before you try to use it.. regulators are uni-directional (gas can only flow in one direction) if hooked up backwards the regulator can be permanently damaged.

There are many, many types of valves for all sorts of purposes. Valves in this catalog are used to control gas flow and to turn gas on/off. Please be aware that there are lots of valves and most are not rated for or appropriate to use with fuel gases (natural gas & propane [lp]). We carry only two types of valves; ball and needle. (The gas cocks we carry are true ball valves, but are designated as such to differentiate them from the ball valves with a larger throughput [hole] and larger handle.) Be aware that some valves are uni-directional; meaning gas can only flow in one direction through them (needle valves).

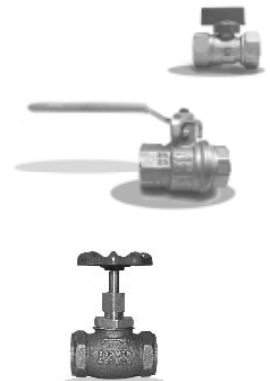

Sold to:	Ship to if different:

Qty.	Item	Unit price	Ext. price

If you are ordering burners, please read page 30 first. Without the information in this box we will not be able to fill your order. Thanks

Type of Gas \_\_\_\_\_ Delivery Pressure \_\_\_\_\_

credit card #		Sub-Total				
<table border="1"> <tr> <td> </td> <td> </td> </tr> <tr> <td> </td> <td> </td> </tr> </table>						TN residents add 9.75%
name on card	exp. date	Shipping*				
phone# _____						

<input type="checkbox"/> check enclosed	*Please call for a shipping quote. **COD orders add \$9.50 and are not permitted on Power Burners.
<input type="checkbox"/> UPS COD**	